

Note:
All Fasteners Supplied
By Installer

WaboFlash Flexible Bellows W/ Metal Flanges (EEJ-600)
Set Flange in Membrane or Substrate Compatible Mastic

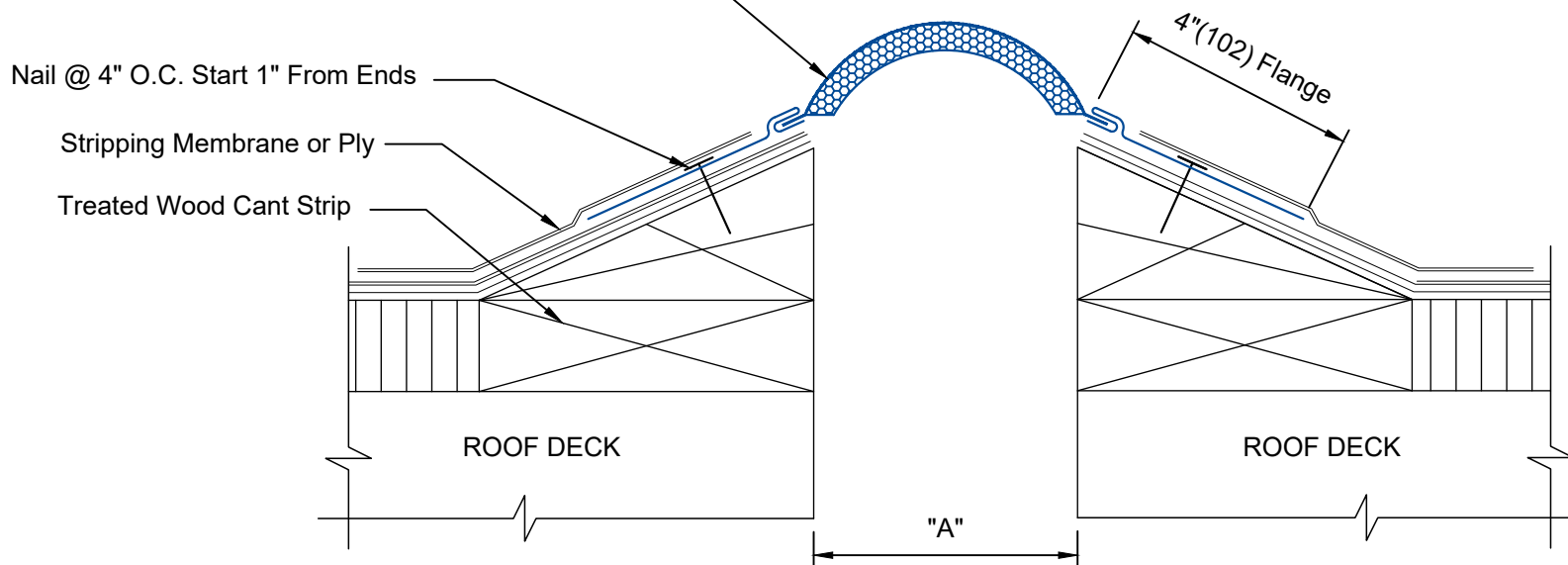

EEJ-600 DETAIL

DESIGN FEATURES

- BLACK EPDM BELLOWS STANDARD
BLACK NEOPRENE AVAILABLE UPON SPECIAL REQUEST
- FLANGE MATERIAL: 26 GA GALVANIZED STEEL STANDARD
(STAINLESS, ALUMINUM, COPPER)
- STANDARD AND CUSTOM FABRICATED INTERSECTIONS
AND DIRECTION CHANGES AVAILABLE
- FLEXIBLE WATERPROOF CLOSURE FOR VERTICAL
WALL APPLICATIONS

() - Denotes Millimeters

DIMENSION CHART				
MODEL	"A" @ MIN	"A" @ MID	"A" @ MAX	TOTAL MOVEMENT
EEJ-600	3"(76)	6"(152)	9"(229)	6"(152)

NOTE: "A" MIN. & "A" MAX. ARE AFTER MOVEMENT OCCURS

PROJECT NAME: -

PROJECT LOCATION: -

DRAWING DESCRIPTION:

Wabo®Flash

DATE: 02/09/2021

MODEL: EEJ



Watson Bowman Acme
95 Pineview Drive Amherst, NY 14228
phone: (716) 691-7566 fax: (716) 691-9239
www.watsonbowmanacme.com

A brand of
MBCC GROUP

Information provided herein, including but not limited to, any drawing, design, photograph, graphic, or statement(s) ("Materials") are proprietary and the property of Watson Bowman Acme Corporation ("Company"). Reproduction, translation, or reduction to any electronic medium or machine readable form, in whole or part, is strictly prohibited, except for the express purpose for which it has been furnished, without prior written consent of Company. All Materials contained herein are provided by Company for information purposes only. Company reserves the right to amend or withdraw any information contained in the Materials without notice. All technical or other advice by Company, whether verbal or written, concerning products, or the use of products in specific situations ("Advice") is given by Company and is used at the Users own risk.

REVISION NO:
1

SHEET NO:
6

DRAWING NO:
A32954