

Installation Procedure

Last Updated: December 2020

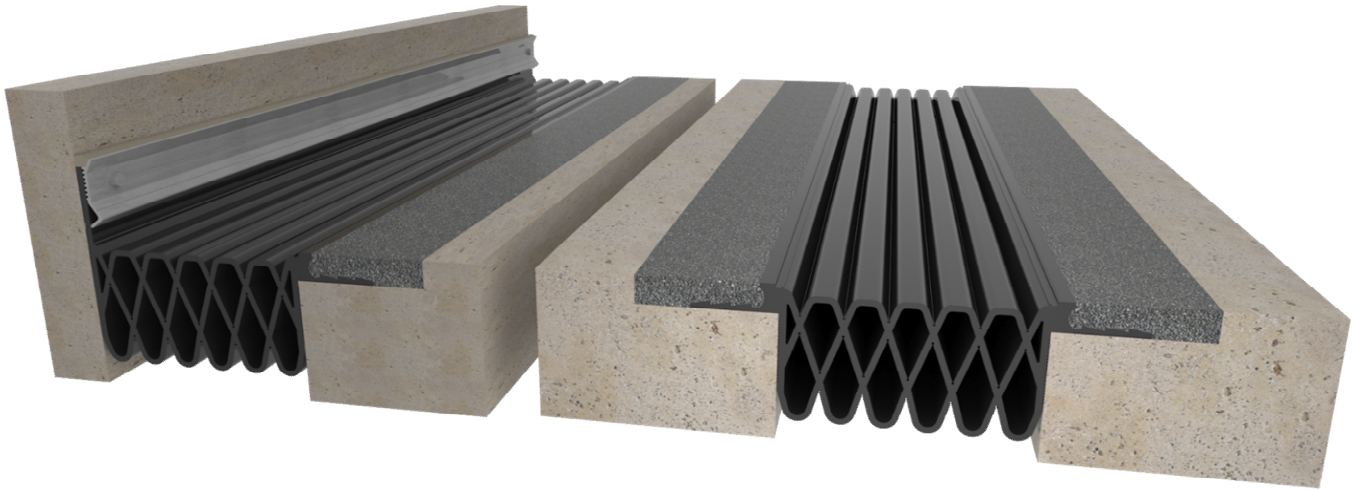

WaboCrete® Membrane Generation II

Membrane Sealing Expansion Joint System

The following installation procedure is very important and must be fully understood prior to beginning any work. To ensure proper installation and performance of expansion joint system the following actions must be completed by the installing contractor. **Failure to do so will affect product warranty.**

- 1) Carefully read and understand installation procedure. Contact WBA's Technical Service Department at (800) 677-4922 for product assistance.
- 2) Inspect all shipments and materials for missing or damaged components and hardware. Contact Customer Service at (800) 677-4922 with WBA's order number and invoice for prompt assistance.
- 3) Inspect substrate or adjacent construction for acceptance before beginning work. Report unacceptable construction to the project manager for scheduled repair work.
- 4) Review WBA shop drawings for project specific detailed information if Engineering services were purchased at time of order.

Information provided herein, including but not limited to, any drawing, design, photograph, graphic, or statement(s) ("Materials") are proprietary and the property of Watson Bowman Acme Corp. ("Company"). Reproduction, translation, or reduction to any electronic medium or machine-readable form, in whole or part, is strictly prohibited, except for the express purpose for which it has been furnished, without prior written consent of Company. All Materials contained herein are provided by Company for information purposes only. Company reserves the right to amend or withdraw any information contained in the Materials without notice. All technical or other advice by Company, whether verbal or written, concerning products, or the use of products in specific situations ("Advice") is given by Company and is used at the User's own risk.

Health & Safety

During the installation of any Watson Bowman Acme product, appropriate personal protective items should be worn at all times, including but not limited to the following:

- Proper work clothing
- Safety glasses
- Safety boots
- Gloves
- Hard hat



Local rules and regulations regarding safe work environments and health should be followed.

Product Components

Required Components



WaboCrete® Parking Series Elastomeric Concrete,
Part A (P/N: 14380H), Part B (P/N: 14385G),
Part C (P/N: 33138)



Wabo® Bonding Agent,
Part A (P/N: 1931J), Part B (P/N: 1933J)



BASF Masterseal 940 50lb Bag (22.68Kg)
(P/N: 33137) for broadcasting onto WaboCrete®
Parking Series Elastomeric Concrete exposed surface.

Required Components (continued)

Components shown below vary in size depending on model of system:

Description	Installation Width				Seal Width (Relaxed)
	Min (in)	Min (mm)	Max (in)	Max (mm)	"A"
ME-250 (#8828X)	1.00	25	1.75	44	1 7/8"
ME-250C (#8828XC)	1.00	25	1.75	44	1 7/8"
ME-300 (#8825X)	1.00	25	2.25	57	2 1/4"
ME-300C (#8825XC)	1.00	25	2.25	57	2 1/4"
ME-450 (#8881X)	1.50	38	3.00	76	3"
ME-450C (#8881XC)	1.50	38	3.00	76	3"
ME-600 (#8883X)	2.00	51	4.00	102	4 3/16"
ME-600C (#8883XC)	2.00	51	4.00	102	4 3/16"
ME-700 (#8885X)	2.50	64	5.00	127	5 3/16"
ME-700C (#8885XC)	2.50	64	5.00	127	5 3/16"
ME-850 (#8887X)	3.00	76	6.00	152	6 3/16"
ME-850C (#8887XC)	3.00	76	6.00	152	6 3/16"

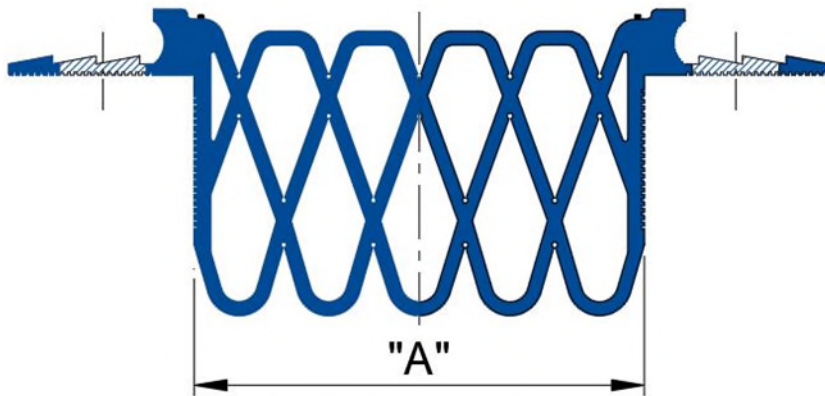

WaboCrete® Membrane Gen II "ME" Series
(See Chart for Seal Sizes)

Optional Products



Scoop (64oz Clear Plastic) P/N: 33150
For use with "Stay-in-Place" Form option



WaboCrete® Elastomeric Concrete Non-Flow Additive
(for sloped, crowned or ramped surfaces) P/N: 14389
Add maximum one bag to one unit of Elastomeric Concrete (see p16)



End Cap Sheet (1/32" x 36" wide)
Thermoplastic End Cap for Seal profile P/N 2969 (optional)

Horizontal to Vertical Application



MasterSeal® NP1 Sealant
(for floor-to-wall conditions) P/N 2826



Ø 1/4" x 2 1/4" lg. Stainless Steel Tapcon P/N 6542
For attachment of wall mount bracket or optional Form

Horizontal to Vertical Application (cont'd)

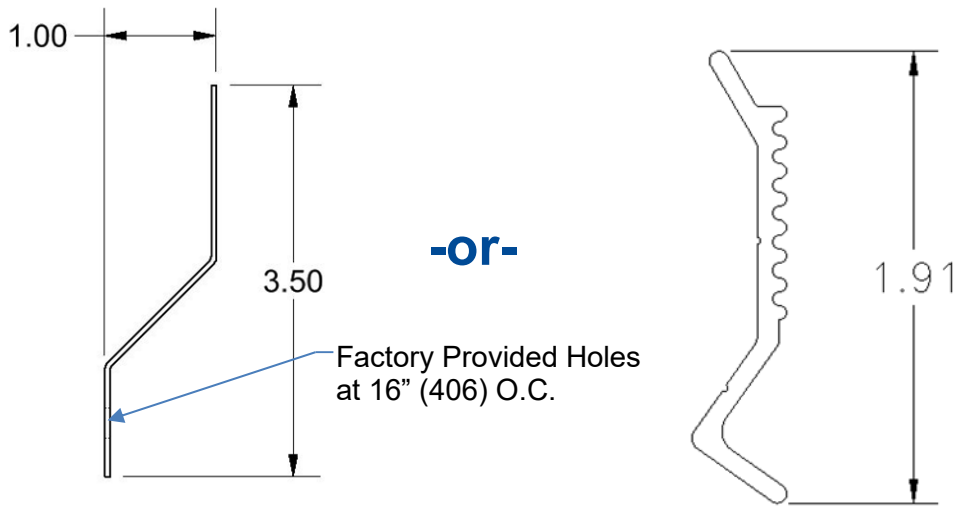

**Optional “Stay-in-Place”
Wall Mount Form**
P/N 5005 (Galvanized Steel)
P/N 5007 (Stainless Steel)

“Standard” (wall mount retainer)
P/N 3091

Accessories for Splicing – Ordered Separately

Splicing Method 1

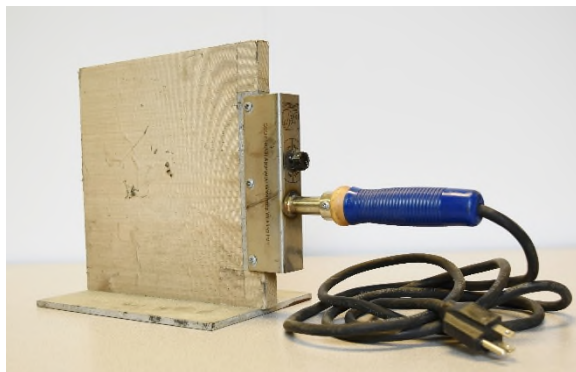

Heat Plate (P/N 3161)

Splicing Method 2



241F Adhesive
P/N 2716



PP Primer
P/N 2717

Pre-Installation Notes

Concrete Substrate must be clean (free of dirt, dust, coatings, rust, grease, oil and other contaminants), sound and durable. New concrete must be fully cured (Min. 14 days) and all laitance removed.

Mask joint edges with duct tape & roofing paper to ensure a clean final appearance.

Clean blockout with dry compressed air. (see Installation Step #1 on next page).

(space intentionally left blank)

Installation

1 Blockouts must be formed to 3 1/2" (89) wide and 3/4" (19) in depth. Abrasive blast the concrete breakout surfaces to remove the foam release agents, grease, bond breakers and to enhance bonding surface. **Note:** Abrasive blasting is the preferred method. Grinding with an aggressive concrete disc is acceptable when abrasive blasting is not possible (i.e. using zec wheel or diamond cup wheel).

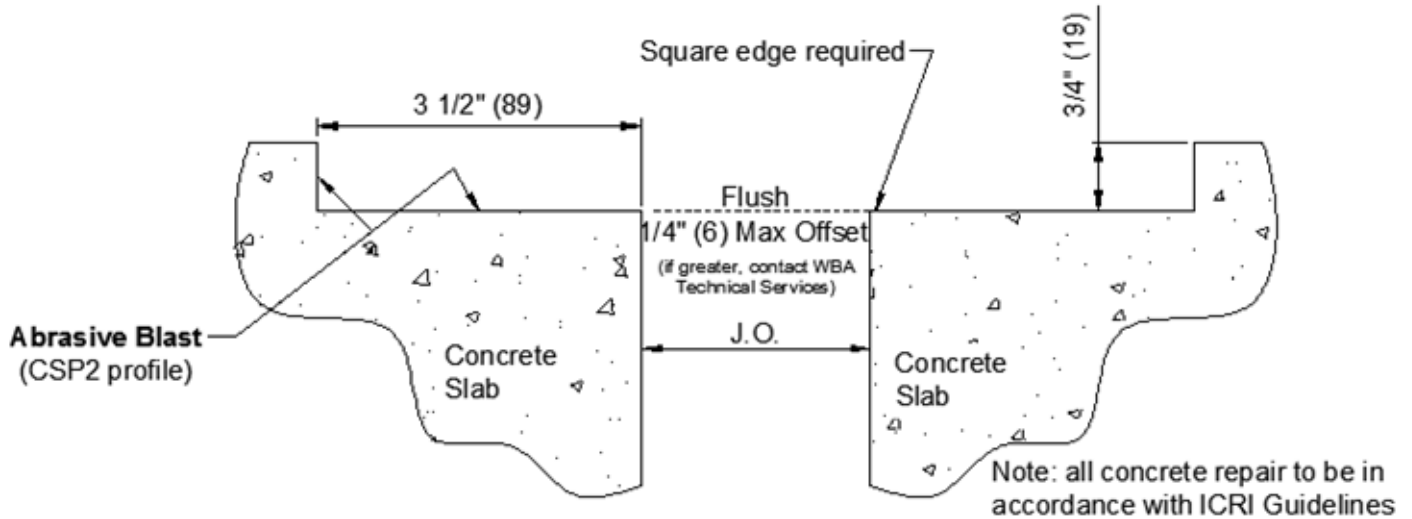

2 Position seal over the joint opening as shown (Fig. 1). Compress bottom portion of seal and insert into joint as shown (Fig. 2). Complete installation by positioning seal within the joint to a depth so that the seal flaps lay flat in blockout. It may be necessary to make relief cuts in seal flaps in order for them to lay flat. Relief cuts should be made in a triangular shape. Do not remove large portions of seal flaps. Remove only enough to encourage seal to flatten – as shown below.

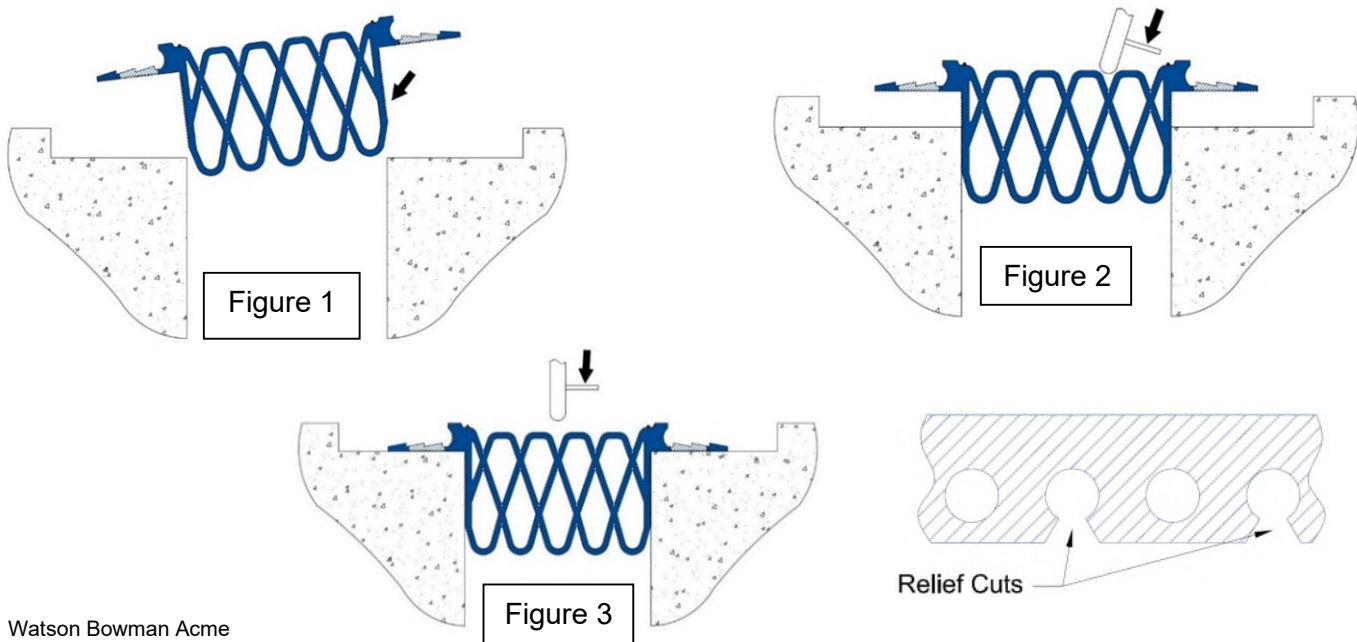

- 3** Tape the top of the seal with duct tape in area shown above. The edges of the blockouts should be covered with roofing paper taped down with duct tape to keep area clean during pouring of WaboCrete® Parking Series Elastomeric Concrete.

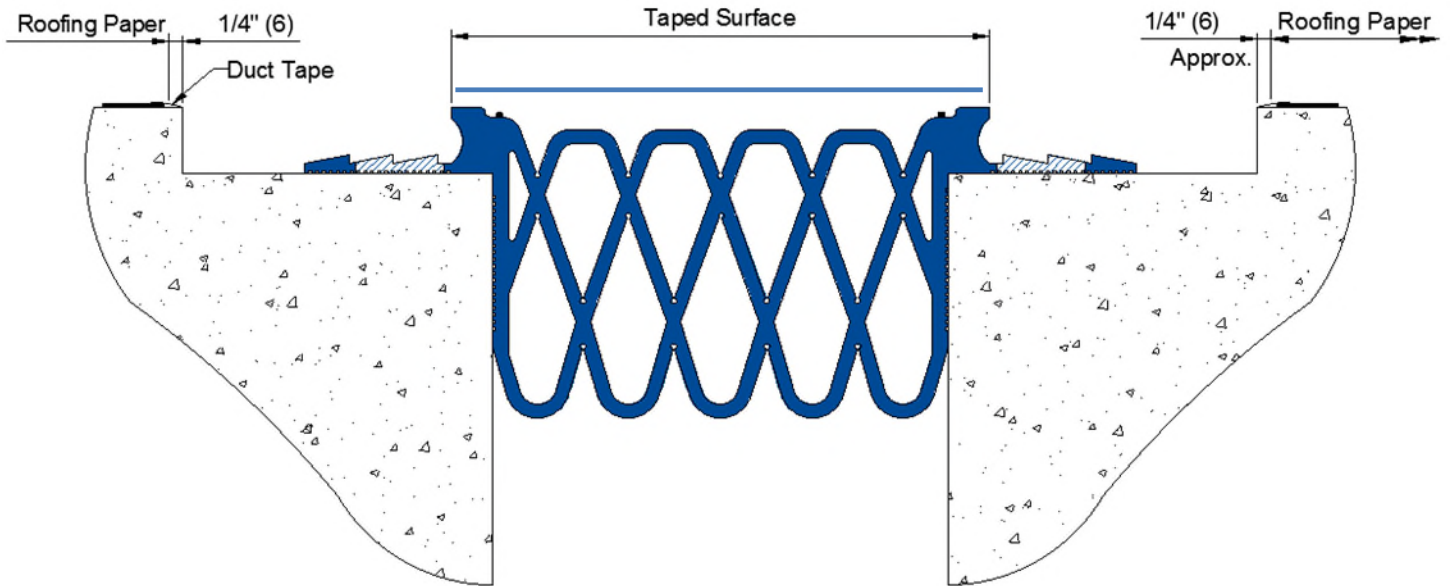

(space intentionally left blank)

4

Wabo® Bonding agent must be used as a primer on the properly prepared dry concrete before beginning the installation of WaboCrete® Parking Series Elastomeric Concrete. **Wabo® Bonding agent is meant for the concrete, it is not required on the seal.** Lift flaps of the seal as shown below and brush apply a thin layer of Bonding agent to the concrete surface and lay flap back down. When Bonding agent is installed, the concrete shall look wet, ensure that ponding or puddles are not occurring. **DO NOT** allow the bonding agent to cure (you must pour wet-on-wet). Immediately following application of bonding agent, begin installation of WaboCrete® Parking Series Elastomeric Concrete.

WaboCrete® Parking Series Note: **DO NOT** mix partial units of WaboCrete® Parking Series Elastomeric Concrete. Thoroughly stir Part B, scraping the can before pouring entire contents of Part B into a clean 5 gallon plastic bucket.

Add Part A and mix both components with a 3/4" Low RPM drill equipped with large grout paddle for 30 seconds and until well blended.

Add aggregate component to the liquid material and mix until all aggregate is coated (Approx. 1.5 minutes). Pour WaboCrete® Parking Series Elastomeric Concrete mix flush to the top of the seal bulkhead and adjacent existing surface. The material will flow and self-level.

Lightly trowel surface to a smooth finish. If desired, solvent (i.e. Xylene, Toluene) can be used while troweling and for cleanup of tools.

After 2-3 minutes, broadcast Masterseal 940 Aggregate to refusal (medium grit). This enhances WaboCrete® Parking Series Elastomeric Concrete aesthetic, UV stability and skid-resistance.

Remove tape from top of seal immediately after installation of Wabo® Crete Parking Series Elastomeric Concrete is completed.

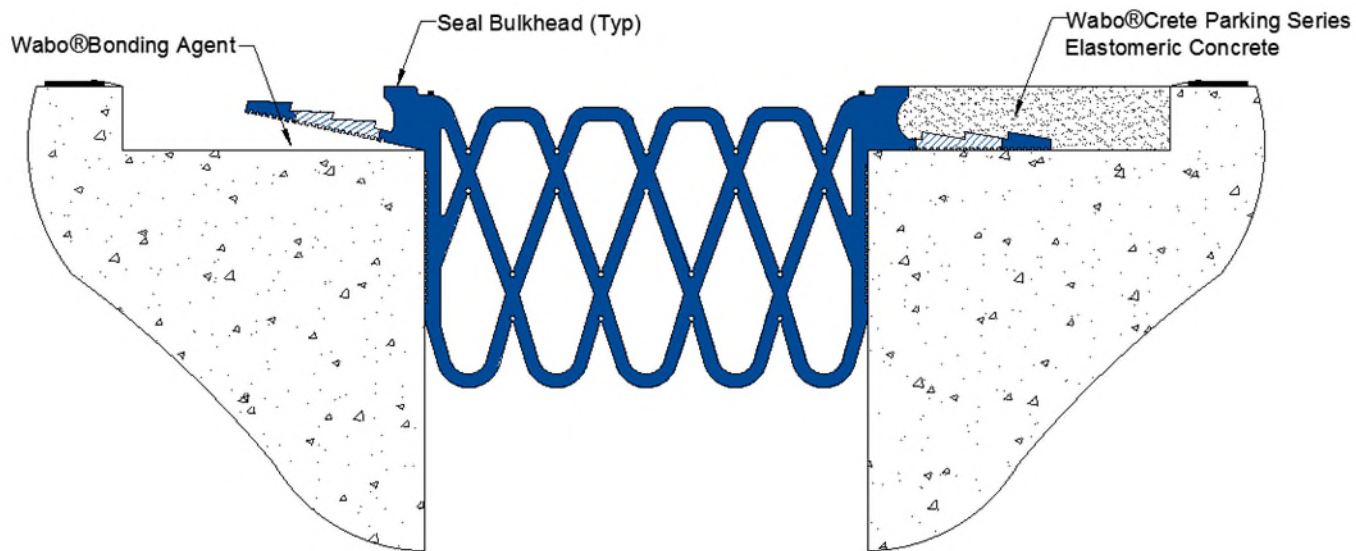

Horizontal to Vertical Applications – Two Options

5A Option #1 – Using standard Retainer/Bracket.

After installation of WaboCrete® Parking Series Elastomeric Concrete (in horizontal), place seal flap up along vertical surface as shown below.

After seal flap is in place, place aluminum wall mount plate against vertical flap as shown below. Fasten wall mount plate to structure utilizing the 1/4" Dia. x 2 1/4" lg Stainless Steel Tapcon Anchors (P/N 6542) supplied.

When installing anchors make sure that the Aluminum Retainer is mounted against the elastomeric seal (see below). This is to ensure that there will be good compression of the seal against the wall. To help ensure a watertight installation apply a continuous bead of sealant (Masterseal NP1 supplied) along top edge of the wall mount plate as shown below.

Note: Manufacturer recommends minimum two anchors at a column installation.

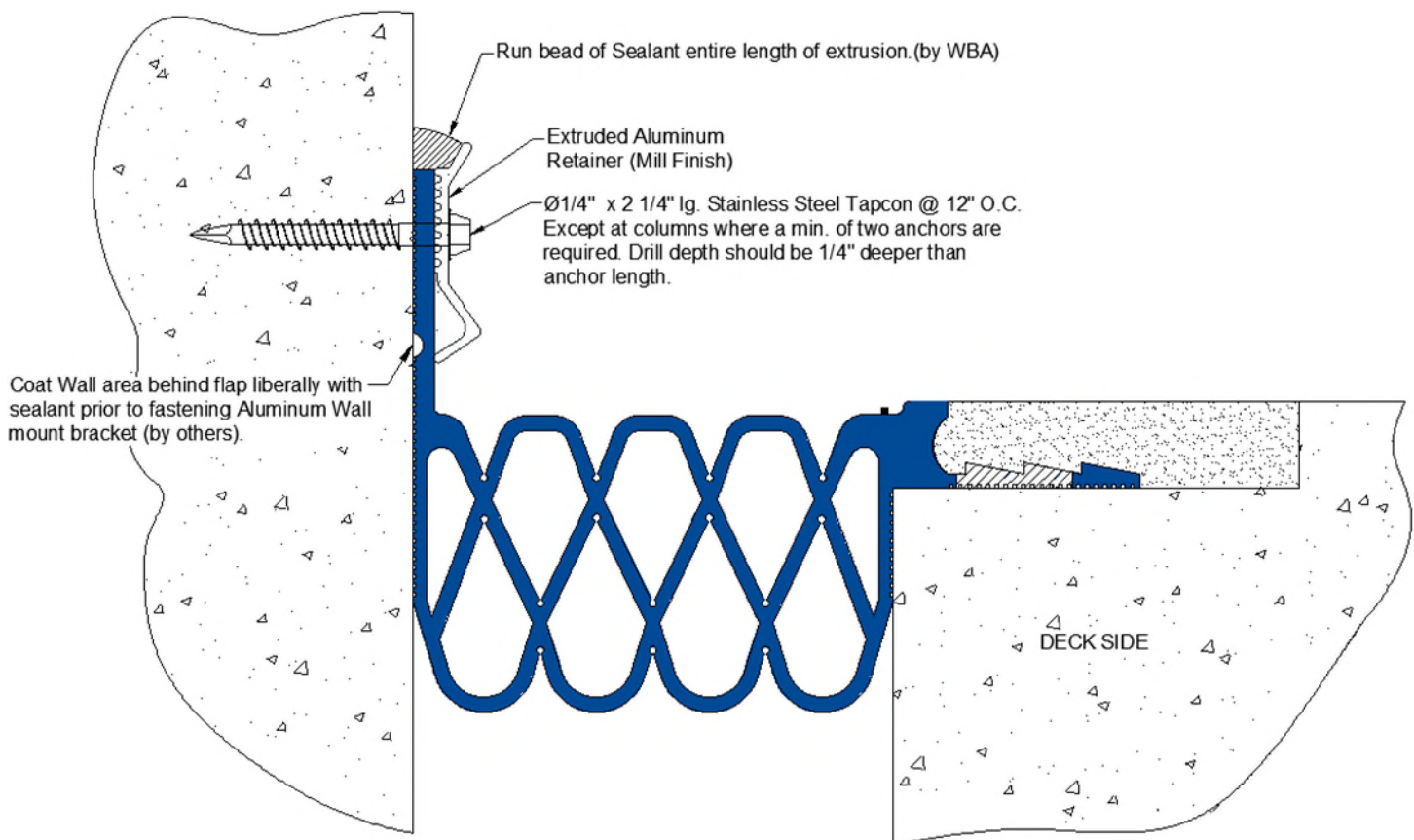

5B Option #2 – Using “Stay-in-Place” Form.

After installation of WaboCrete® Parking Series Elastomeric Concrete (in horizontal), place seal flap up along vertical surface as shown below. After seal flap is in place, slide Stay-in-Place Form against vertical flap as shown below. Fasten Stay-in-Place Form to structure utilizing the 1/4" Dia. x 2 1/4" Ig Stainless Steel Tapcon anchors (P/N 6542) supplied. When installing anchors make sure that the Stay-in-Place Form is mounted against the elastomeric seal as shown below. This is to ensure that there will be good compression of the seal against the wall. To help ensure a watertight installation, use WaboCrete Parking Series to in-fill the Stay-in-Place Form. (Note: manufacturer recommends a “reduced pour” for this section (remove approximately 5.0 lbs of Part C aggregate before mixing) as shown below.

Note: Manufacture recommends minimum two anchors at a column installation.

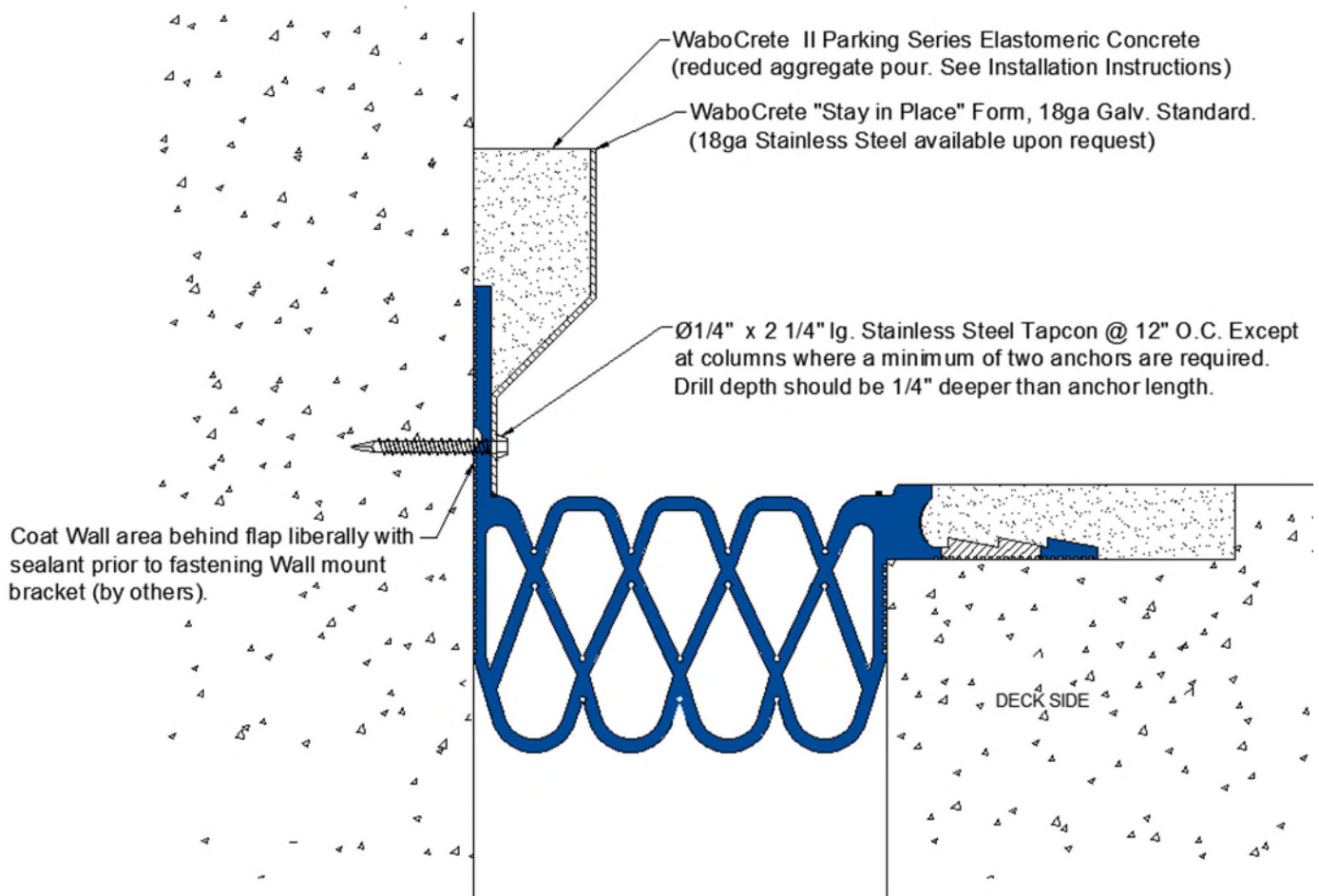

6A Apply Masterseal 940-Horizontal Only application

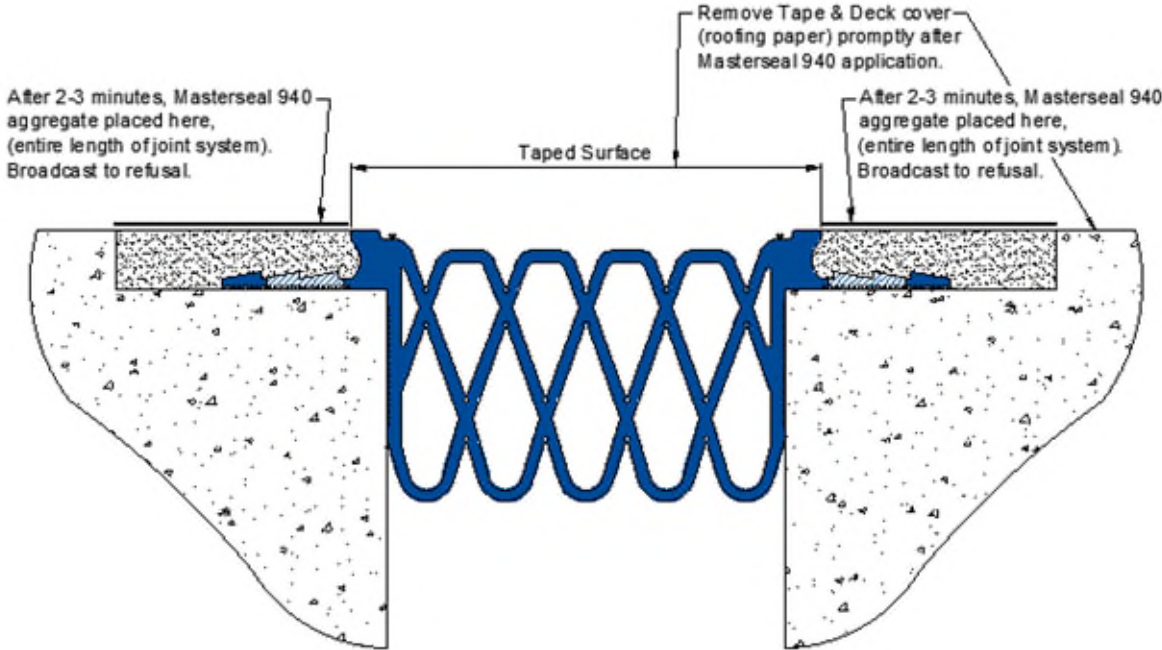

6B Apply Masterseal 940-Horiz to Vert application

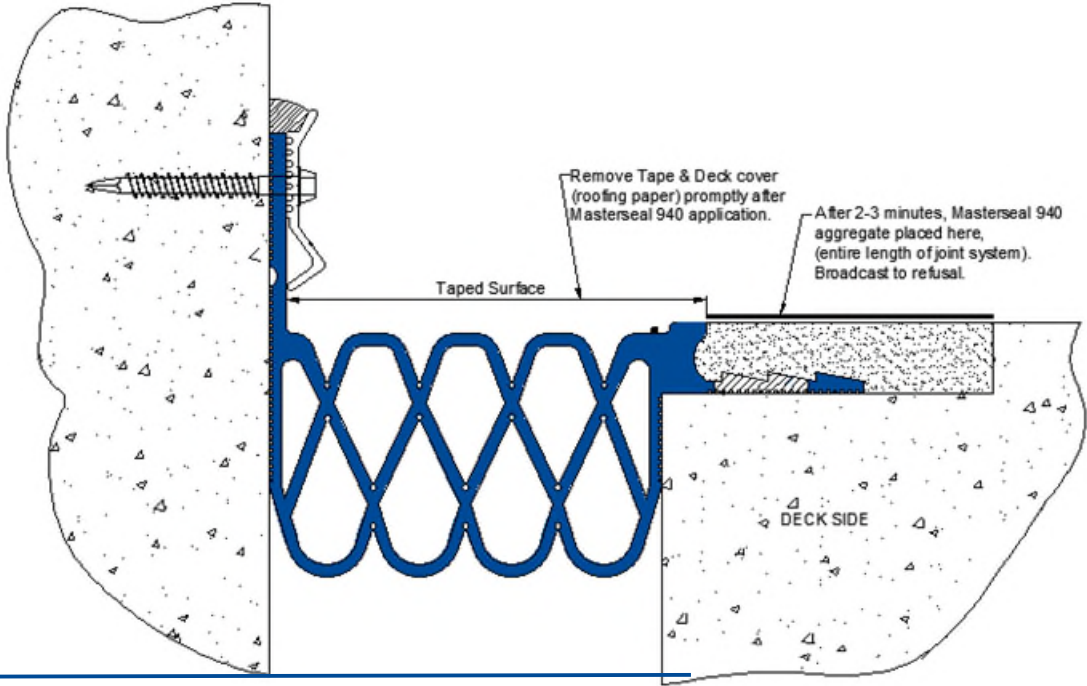

7 Completed Installation Pictures (for reference)

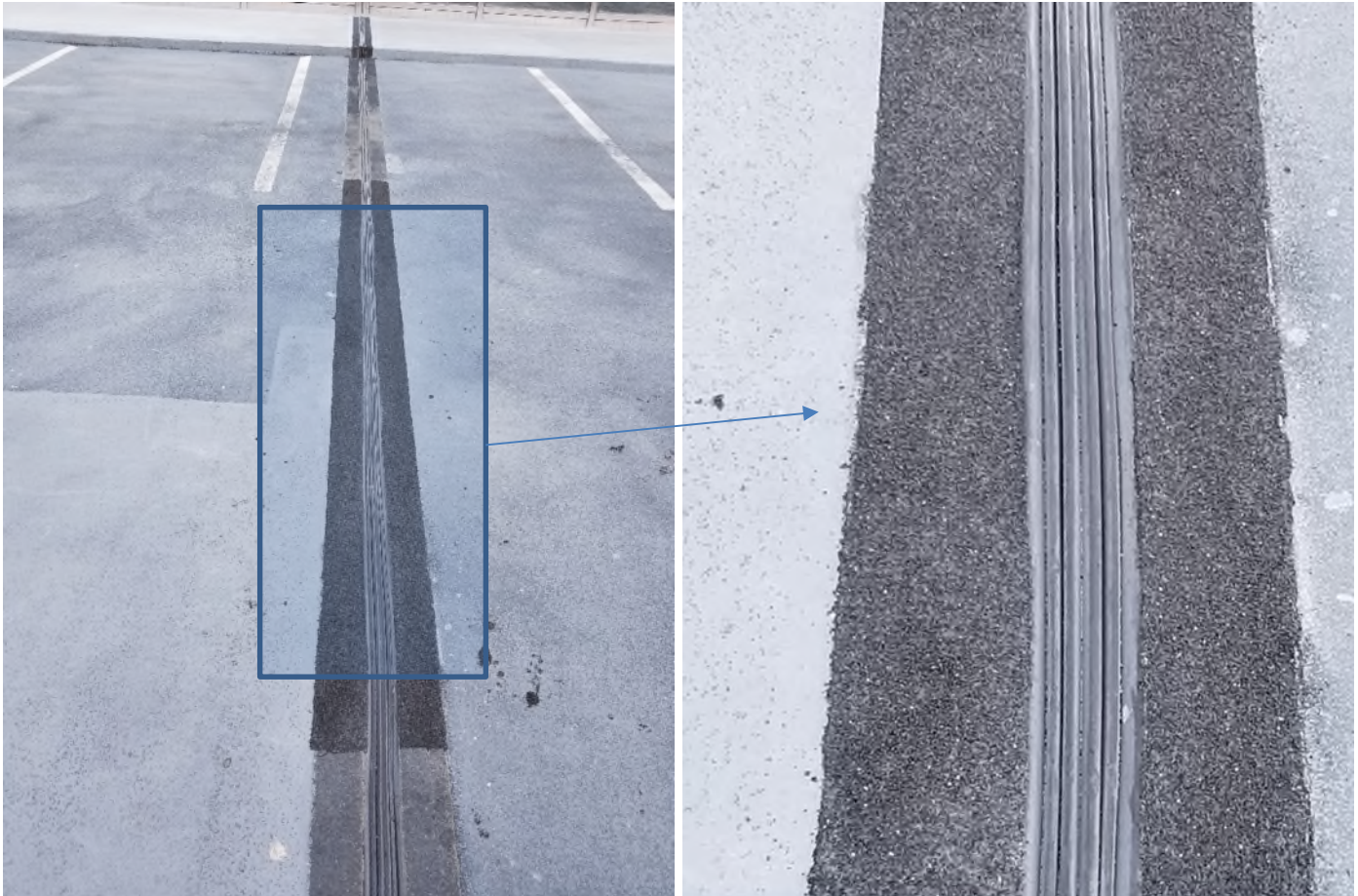

8

Notes: At all vertical changes in direction, utilize 1/4" diameter anchors to properly secure seal flap to base of vertical blockout. Do not over tighten anchor. Tighten enough to achieve direct contact between flap & concrete.

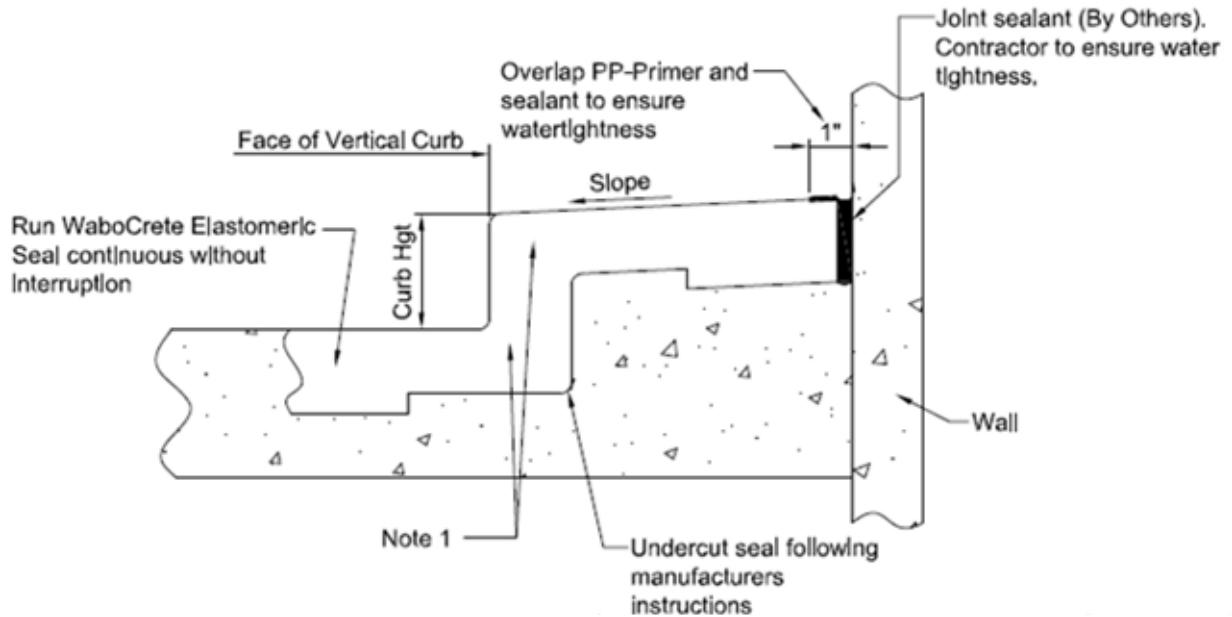

9

Recommended Method:

- Using a miter box and back saw with no teeth, cut seal ends square.
- Preheat heat plate to 425 , Approximately 15 minutes.
- Bring gland into contact with heat plate. Leave the gland touching the heat plate for about 1-2 minutes.
- Remove seals. Once edges have been aligned apply enough pressure to cause the ends of the glands to slightly protrude upwards. Allow approximately 3 to 4 minutes of cure time prior to touch up.

Secondary Method:

- Using a miter box and back saw with not teeth cut seal ends square.
- Clean ends of seal and apply PP Primer. Allow PP Primer to flash off before applying 241 F adhesive.
- Apply 241 F Adhesive to one side only and hold seals together for 45 seconds. Let cure for 2-3 minutes. (For best results, bond small portions of the seal at a time)
- Splice will reach full strength in 24 hours.

Touch Up:

Using soldering gun with a flat tip, run along the splice to make any touch ups. Careful not to burn any holes in the seal.

MEMBRANE 201

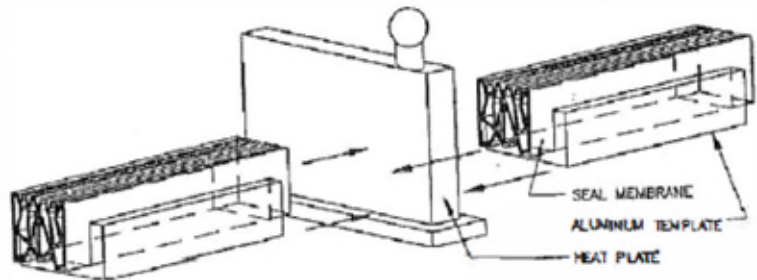

MEMBRANE 101

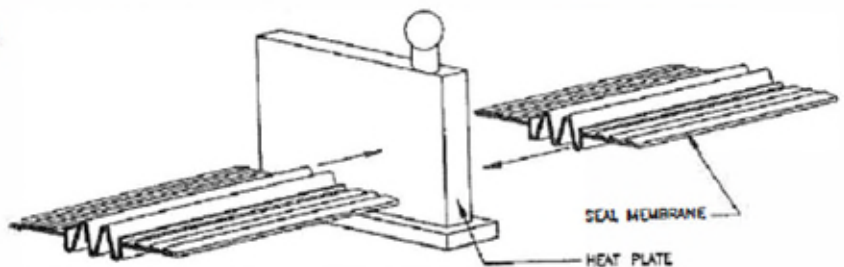



Recommended Equipment for Mixing of

Elastomeric Concrete

- Abrasive blasting Equipment
- 3/4" Heavy Duty Drill (1 hsp - Low RPM)
- 3/8" Hand Drill
- (1) Large Grout Paddle (4" to 6")
- (1) Small Paddle (2")
- (1) Roll of 15lb Roofing Paper
- (2) Clean 5 gallon plastic buckets
- (4) Clean 1 gallon plastic buckets (For bonding agent)
- (8) 2" disposable paint brushes (For Bonding agent)
- Rubber gloves
- (8) 2" Margin trowels
- Misc. hand tools and extension cords



for WaboCrete Parking Series:

WaboCrete® Parking Series will yield .60 ft³.

- One unit of WaboCrete® Parking Series = One US half gallon Part A, One gallon Part B, and one 60 lb Container of aggregate. the formula for calculating volume is: (length in feet x width in inches x depth in inches)/ 86.4 = Number of units of WaboCrete® Parking Series needed to complete the job.

Example

Based on a blackout size 3 1/2" wide x 3/4" deep x 30' long:

The calculation would be: (.0304 x 30)= .91 units. This calculation is for only ONE side of the bockout.

Curing of WaboCrete®:

WaboCrete® Parking Series is an ambient cure material. Cure times are therefore, temperature dependant.

Suggested cure times are listed below:

Cure Time: 21° - 32°C (70°-90°F) -1 to 1 1/2 Hours
 (Open to Traffic) 10° - 21°C (50°-70°F) - 1 1/2 to 2 Hours
 4° - 10°C (40°-50°F) - 2 to 3 Hours

Sloped Conditions (using Non-Flow Additive):

1. Premix Part B for 20 seconds (Scraping sides and bottom of can)
2. Pour Part B into clean empty 5 gallon bucket
3. Add Non-Flow additive, blend for 30 seconds
4. Pour into Part A
5. Add Part C and mix for 1.5 minutes
6. Pour into blockout and work Wabo@Crete Parking Series with trowel into sloped condition until it sets up and stays in sloped position.

Notes:

All yields are approximate and do not include allowance for uneven blockouts, waste etc.

Follow us on social media for industry news, new product announcements & more:

