

Installation Procedure

Last Updated: November 2018

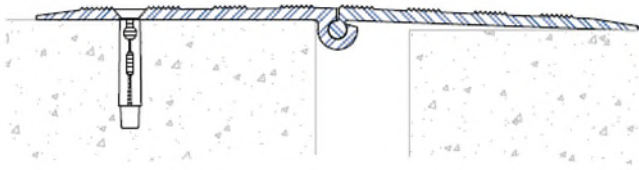

Model – HDH Floor Condition

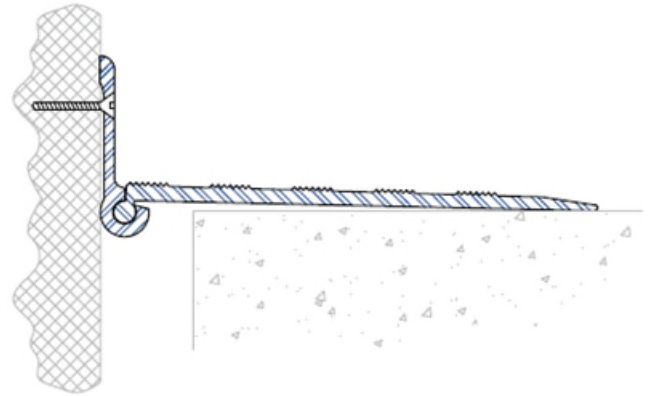

Model – HDH Corner Condition

Wabo®HingeMount “HDH”

The following installation procedure is very important and must be fully understood prior to beginning any work. To ensure proper installation and performance of expansion joint system the following actions must be completed by the installing contractor. Failure to do so will affect product warranty.

- 1) Carefully read and understand installation procedure. Contact WBA's Technical Service Department at (800) 677-4922 for product assistance.
- 2) Inspect all shipments and materials for missing or damaged components and hardware. Contact Customer Service at (800) 677-4922 with WBA's order number and invoice for prompt assistance.
- 3) Inspect substrate or adjacent construction for acceptance before beginning work. Report unacceptable construction to the project manager for scheduled repair work.
- 4) Review WBA shop drawings for project specific detailed information if Engineering services were purchased at time of order.

Information provided herein, including but not limited to, any drawing, design, photograph, graphic, or statement(s) ("Materials") are proprietary and the property of Watson Bowman Acme Corp. ("Company"). Reproduction, translation, or reduction to any electronic medium or machine readable form, in whole or part, is strictly prohibited, except for the express purpose for which it has been furnished, without prior written consent of Company. All Materials contained herein are provided by Company for information purposes only. Company reserves the right to amend or withdraw any information contained in the Materials without notice. All technical or other advice by Company, whether verbal or written, concerning products, or the use of products in specific situations ("Advice") is given by Company and is used at the User's own risk.

Health & Safety

During the installation of any Watson Bowman Acme product, appropriate personal protective items should be worn at all times, including but not limited to the following:

- Proper work clothing
- Safety glasses
- Safety boots
- Gloves
- Hard hat



Local rules and regulations regarding safe work environments and health should be followed.

Product Components

The following components are required for the installation of this product.

Standard components:



Floor Mount Anchor
(Varies according to job specifications)

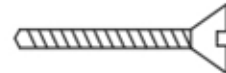

* Wall Mount Anchor
(Varies according to job specifications,
by installing contractor)

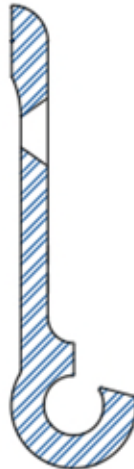

* Wall Mount (Socket)

Components below vary in size depending on model of system:

Dimensional Chart		
Model	"A"	"B"
HDH-200	4 1/2"	3 1/2"
HDH-300	6 3/8"	6 3/4"
HDH-600	6 5/8"	10"

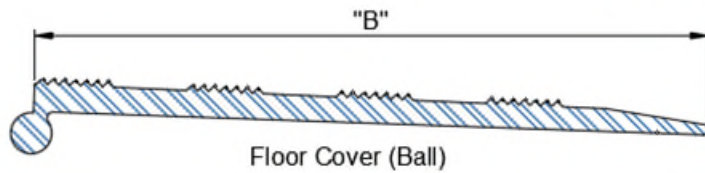
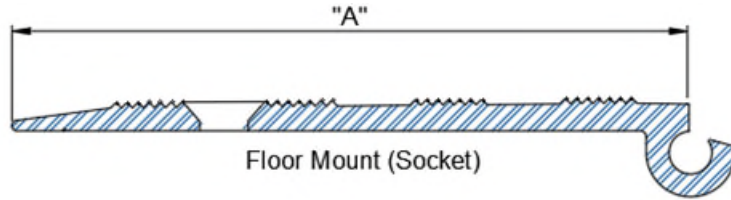

Dimensional Chart	
Model	"C"
HDH-200C	3 1/2"
HDH-300C	6 3/4"
HDH-600C	10"

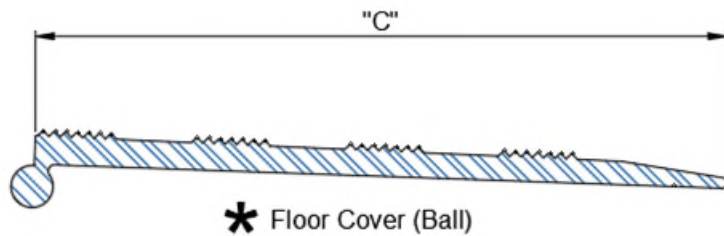

* Components required for corner condition installation.

Installation Procedure for Floor Condition

1 Floor - Prior to beginning work, installer shall inspect corners of concrete slab for acceptability. For repair (if required), refer to step 2. Also, measure joint opening for proper size as called for on W.B.A. shop drawings or CAD detail.

***Note:** May not comply with current ADA Guidelines.

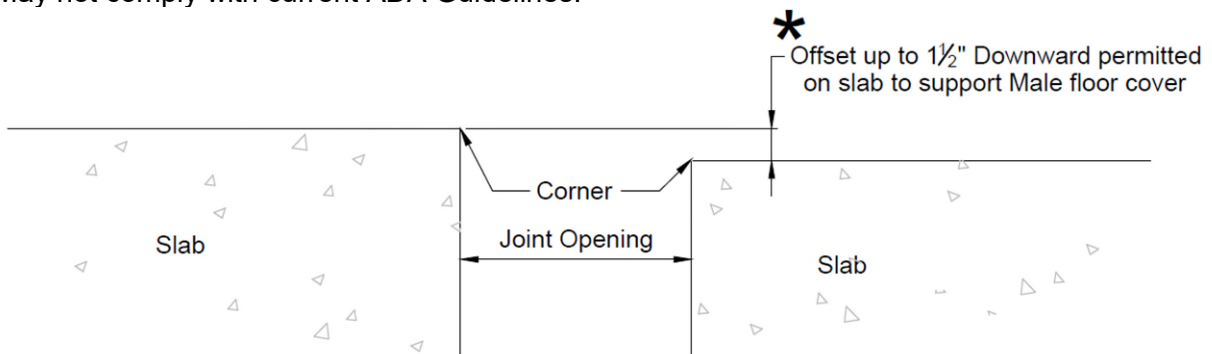

- 2** Utilizing concrete repair material, repair corner of concrete slab following manufacturer's written instructions.

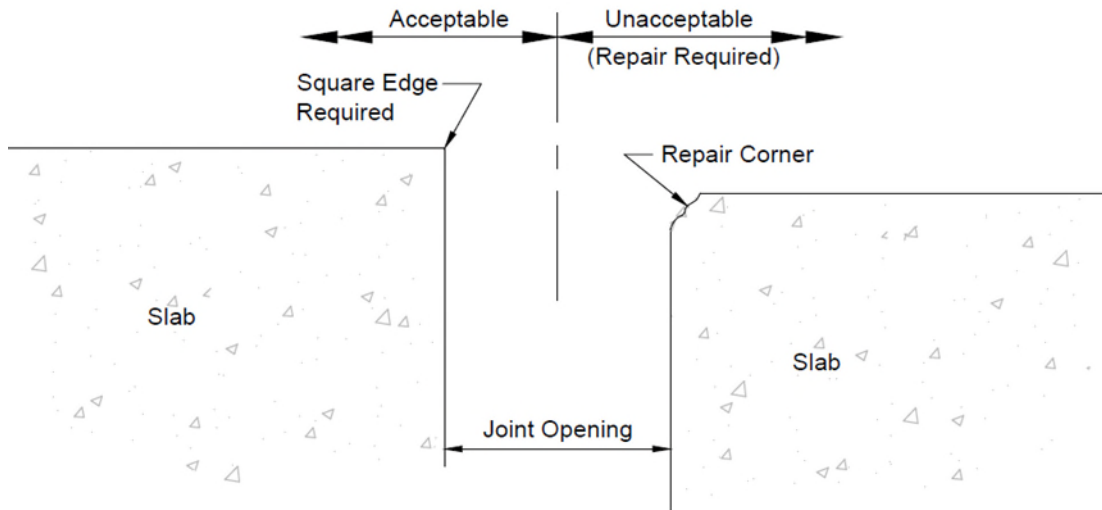

- 3** Assemble system by sliding floor cover ball into female floor mount socket.
Note: When assembling the two halves together, WD40 could be used as a lubricant. If necessary, you may need to use a hammer to assemble. When using a hammer, utilize wood blocking to avoid damage to aluminum profiles.

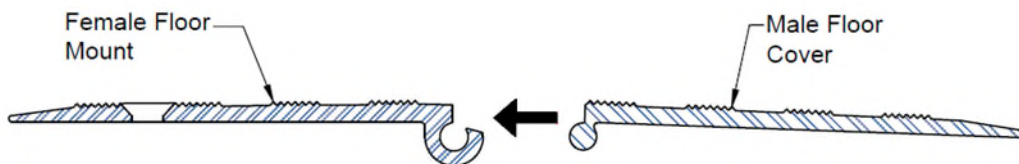

- 4** Ensure that the slab's surface is smooth. High spots are to be ground down and low spots filled in. Make sure slab is clean by sweeping and/or vacuuming. Cut and fit expansion joints to required length. If installing more than one piece, lay out entire run to ensure proper alignment. Make sure female floor mount is mounted against inside wall of opening. Also, if a vertical offset exists, the female floor mount should always be mounted on the high slab.

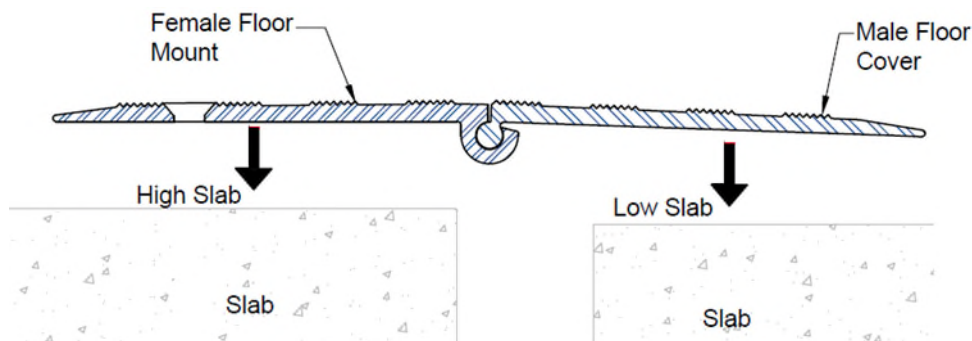

- 5** Drill hole ends first. This ensures that the expansion joint will not move and alignment with other joints is obtained. Follow anchor manufacturer's recommendations for drilling operation. Drill holes to proper depth and clean out holes.

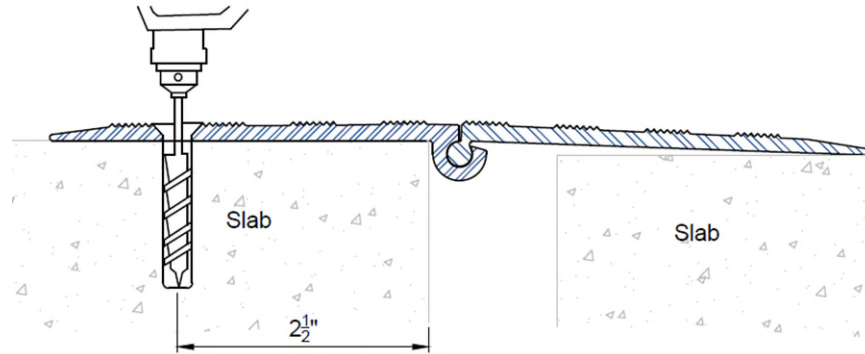

- 6** Follow anchor manufacturer's recommendations for proper anchor installation. Once anchors are installed in the end holes, drill remaining holes and install remaining anchors.

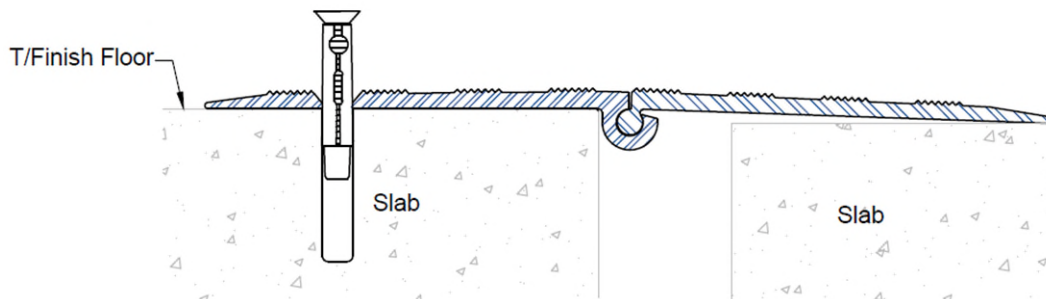

Installation Procedure for Corner Condition

- 1** **Corner** - Prior to beginning work, installer shall inspect corners of concrete slab for acceptability. For repair (if required), refer to step 2. Also, measure joint opening for proper size as called for on W.B.A. shop drawings or CAD detail.

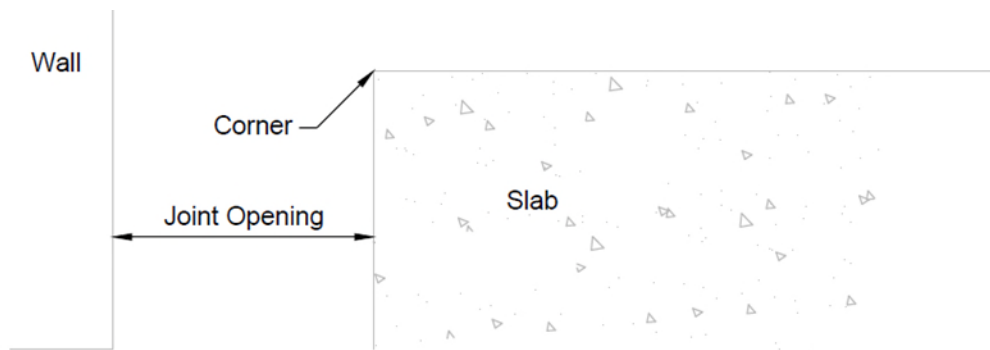

2

Utilizing concrete repair material, repair corner of concrete slab following manufacturer's written instructions.

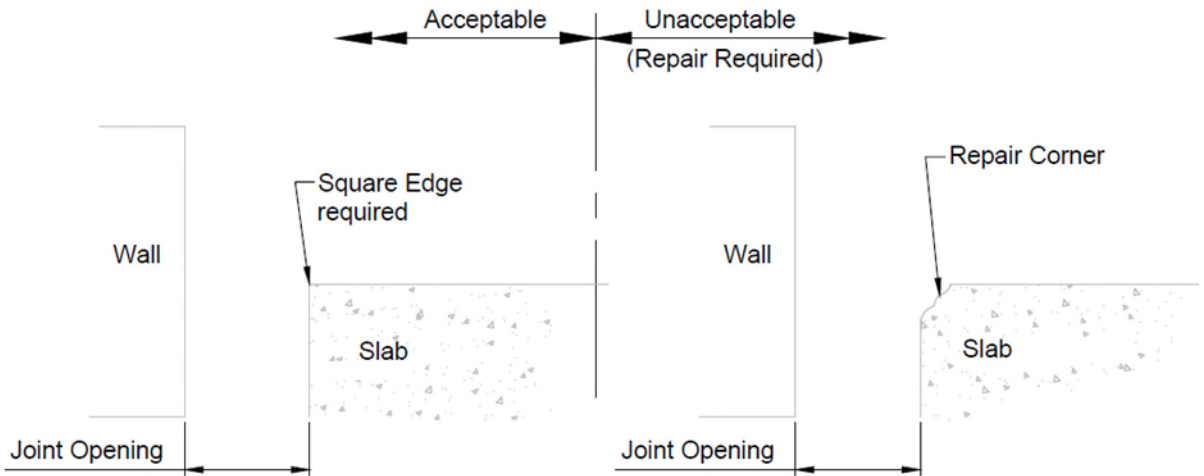

3

Assemble system by sliding floor cover ball into wall mount socket.

Note: When assembling the two halves together, WD40 could be used as a lubricant. If necessary, you may need to use a hammer to assemble. When using a hammer, utilize wood blocking to avoid damage to aluminum profiles.

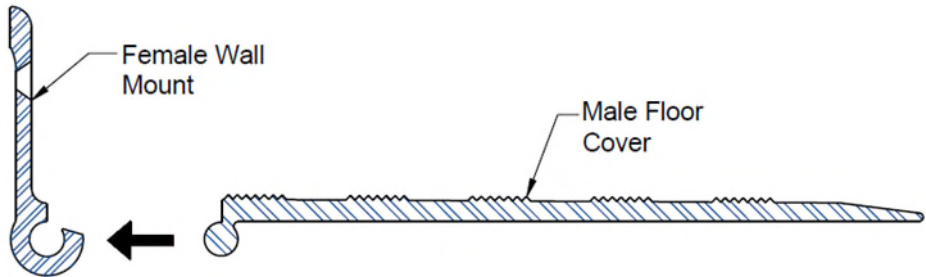

- 4** Ensure that the slab's surface is smooth. High spots are to be ground down and low spots filled in. Make sure slab is clean by sweeping and/or vacuuming.
Note: Cut and fit expansion joints to required length. If installing more than one piece, lay out entire run to ensure proper alignment. Install expansion joint w/ slab at its highest vertical point with joint in a 90° degree angle. Slide expansion joint on slab until the Wall Mount is abutted with the wall.

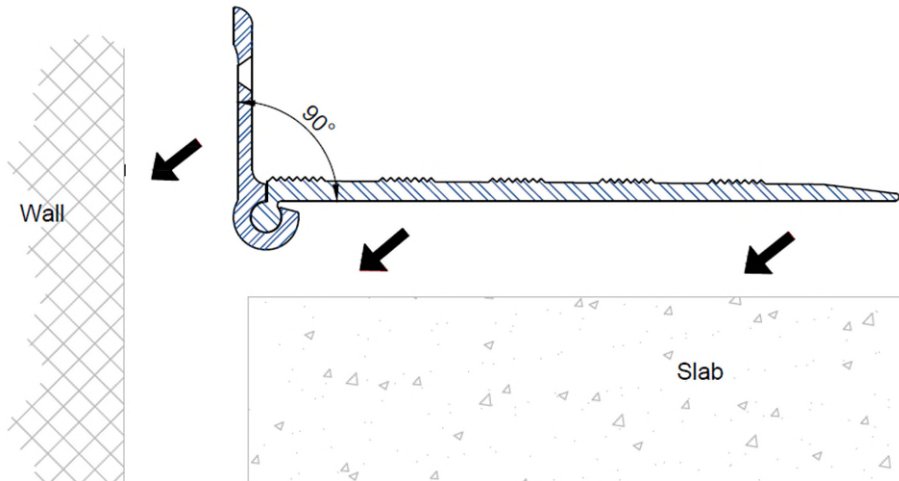

- 5** Drill holes at ends first. This ensures that the expansion joint will not move and alignment with other joints is obtained. Follow anchor manufacturer's recommendations for drilling operation. Drill holes to proper depth and clean out holes.

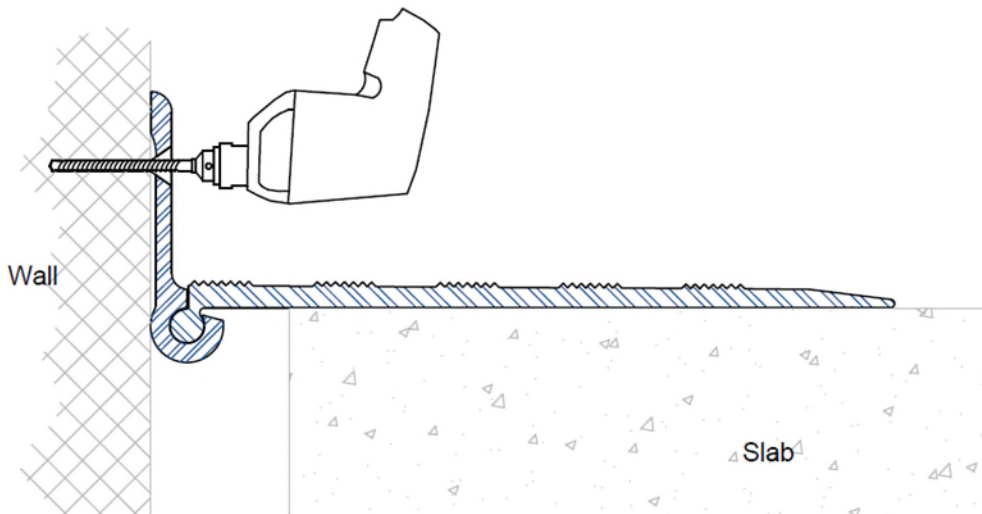

- 6** Follow anchor manufacturer's recommendations for proper anchor installation. Once anchors are installed in the end holes, drill remaining holes and install remaining anchors.

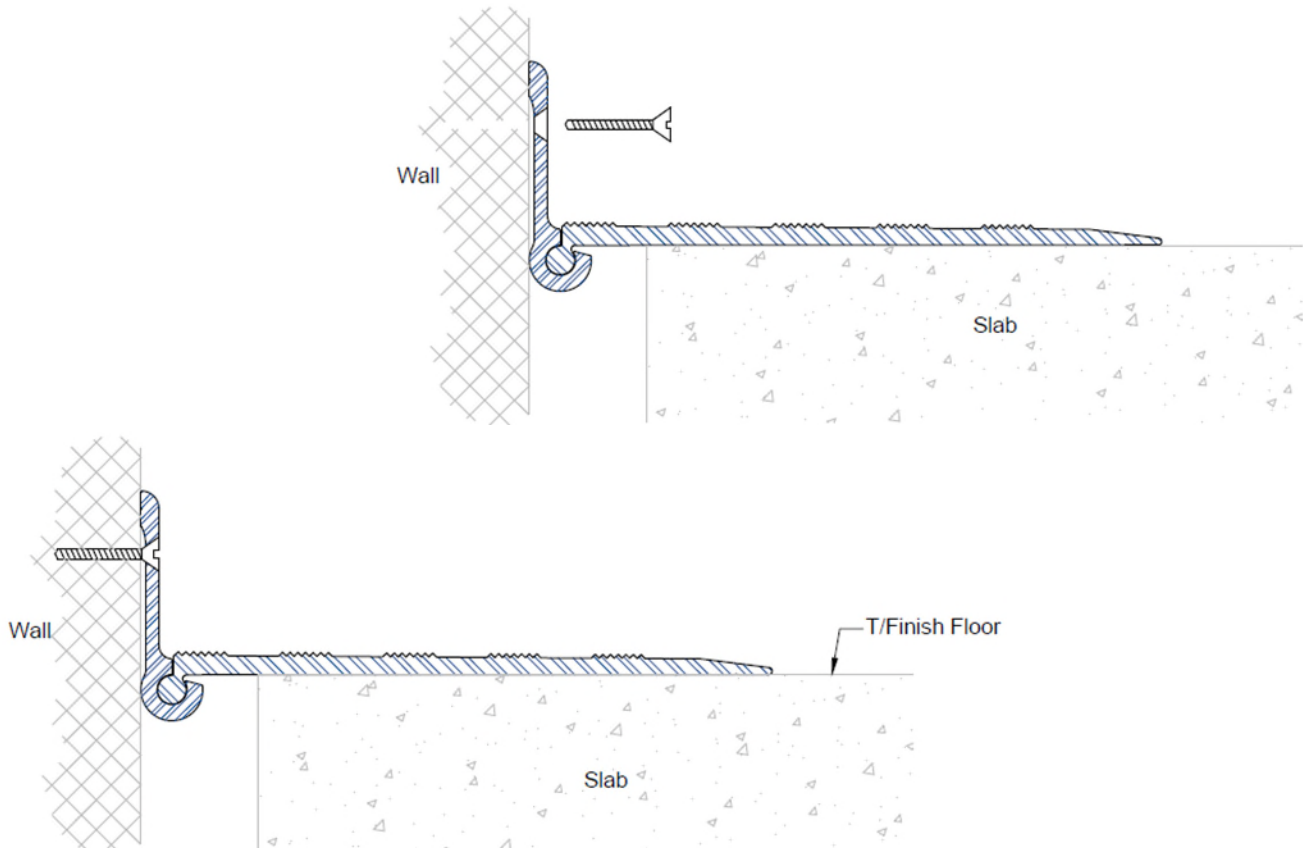

*Watson Bowman Acme is your Strongest Partner for Expansion Joint Systems & Responsible Solutions.
Follow us on social media for industry news, new product announcements & more:*

